

Main Frame

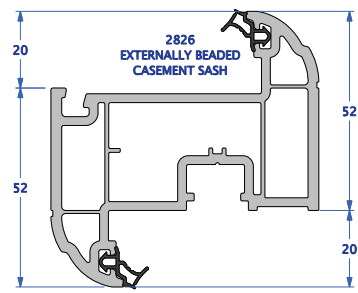

Glazing Bead

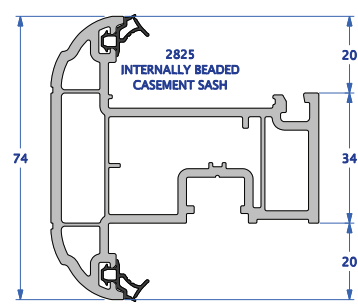
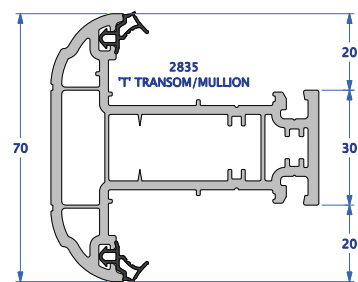
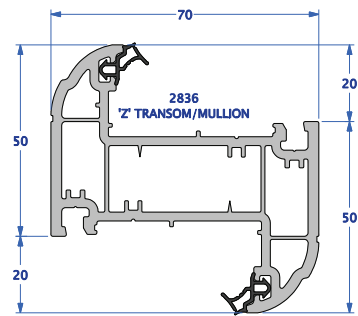
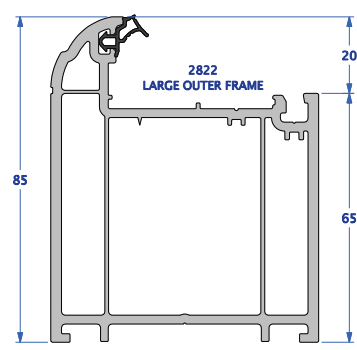
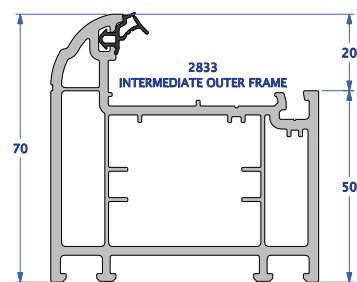
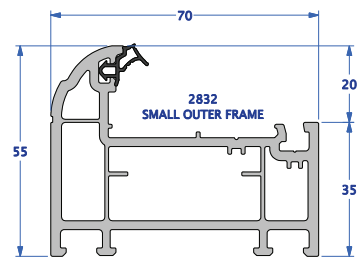

Cills

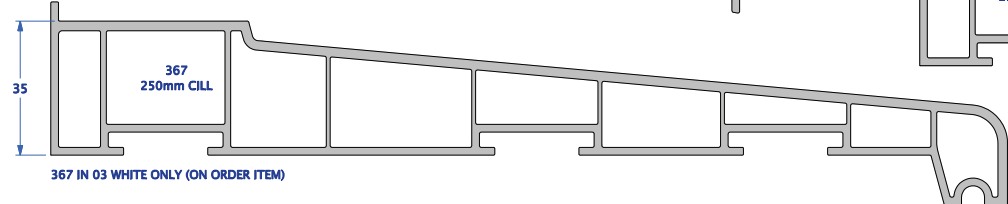
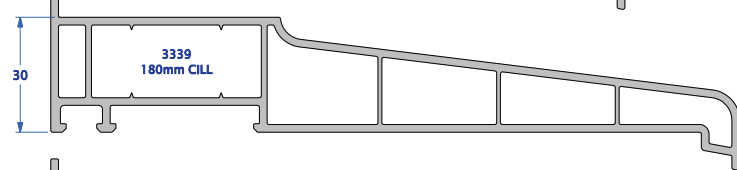
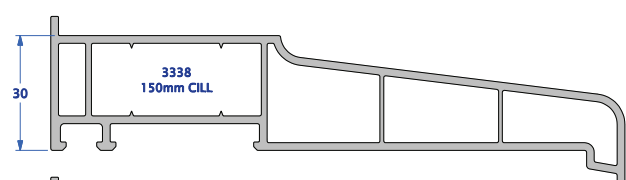
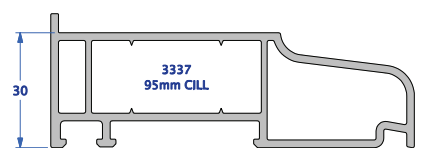

367 IN G3 WHITE ONLY (ON ORDER ITEM)

NOTE: IF USING 367 CILL, THE OUTER FRAME MUST LOCATE BEHIND CILL UPSTAND (AS SHOWN ABOVE) DUE TO CILL PLATFORM BEING SHORTER.

Ancillaries

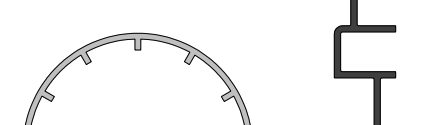
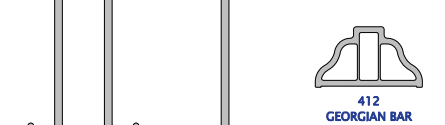
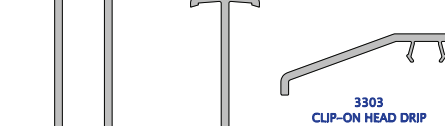
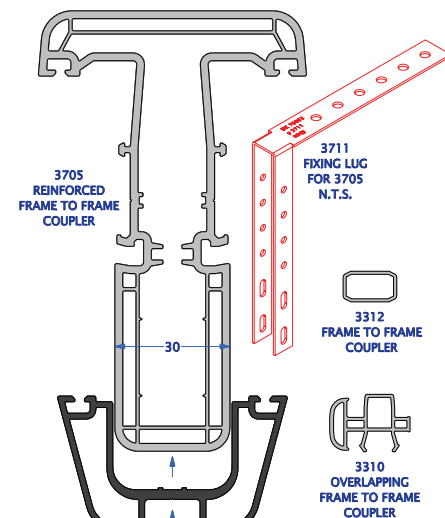
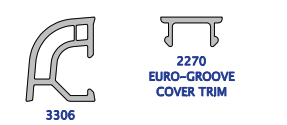
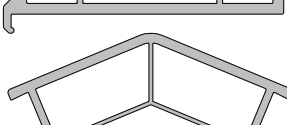
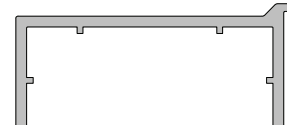
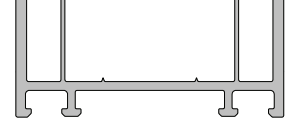
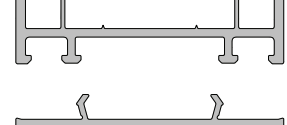
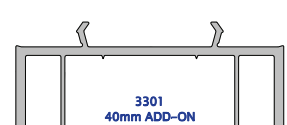
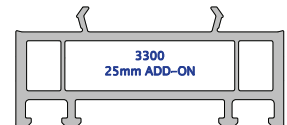
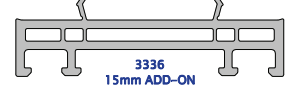

Low Threshold

AVAILABLE IN KIT FORM. KIT CONTAINS MATERIAL FOR 3 SINGLE DOORS. KIT REF. P 14686

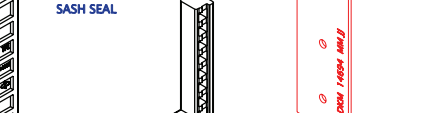
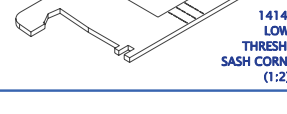

Injection Mouldings & Remaining Ancillaries

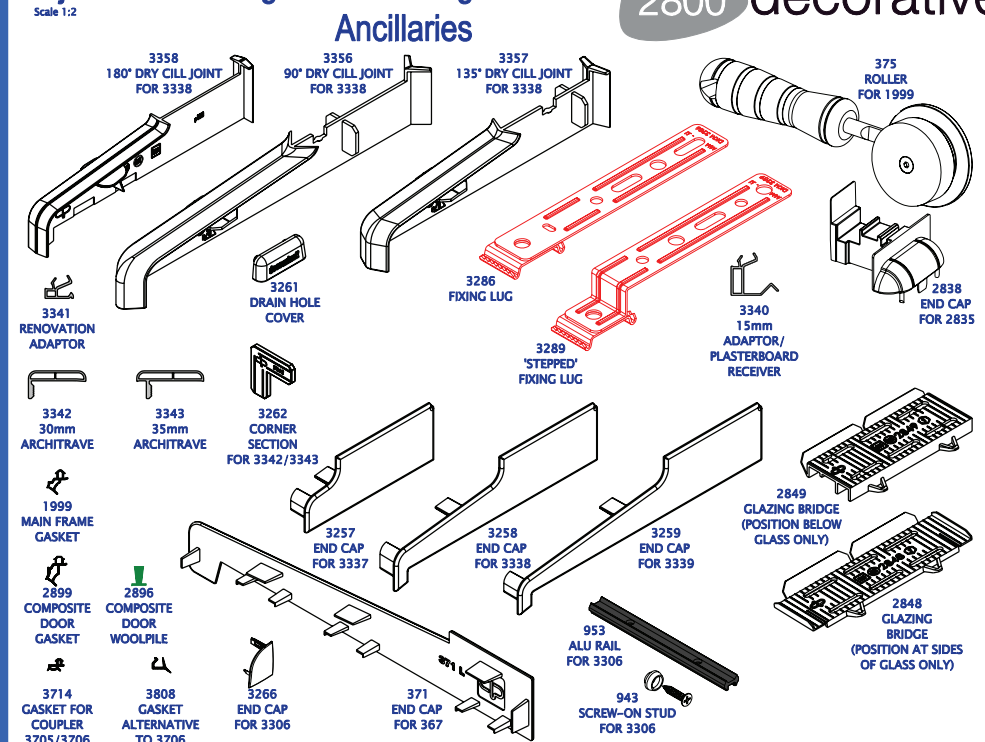

Reinforcement

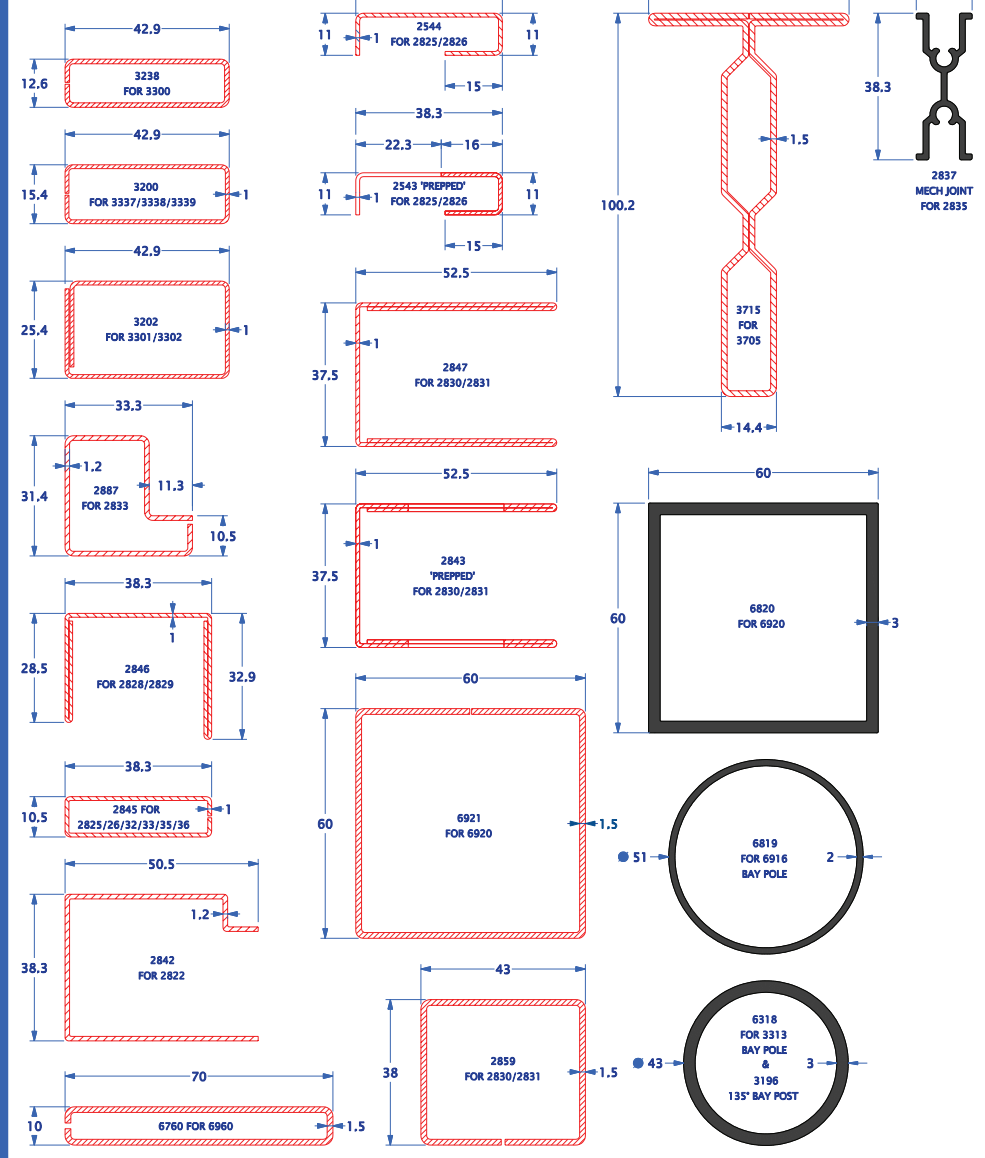

2800 decorative

